

PAM-TDS **NEW!**

POMPA A MANO CON DEVIATORE A 4 VIE - CENTRO CHIUSO
HAND PUMP WITH 4-WAY DIVERTER - CLOSED CENTRE

PREDISPOSTA PER SERBATOIO
SUITABLE FOR OIL TANK

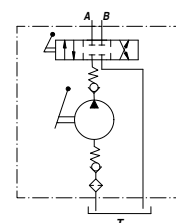
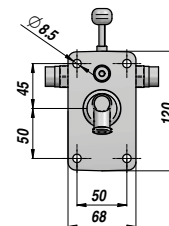
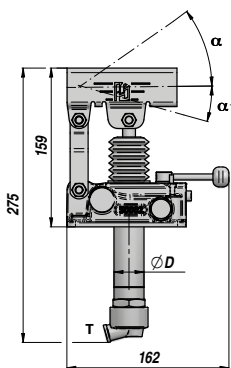
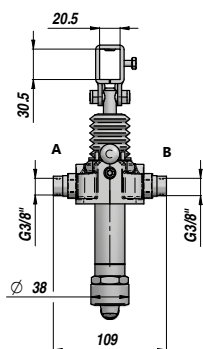
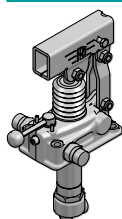

Codice Code	Tipo Type	cm3/ciclo cm3/cycle	P MAX bar	ØD	α	α ₁	Temperatura d'esercizio Working Temperature	kg
PAM0151201	PAM-TDS 12	12	380	30	37°	13°		3,01
PAM0152501	PAM-TDS 25	25	350	35	57°	15°	-20°C +80°C	3,12
PAM0154501	PAM-TDS 45	42	280	40	52°	28°		3,24

Funzionamento D.E. per cilindro D.E. - Double-stroke for a D.A. cylinder

A RICHIESTA - ON REQUEST:

PAMX-TDS = POMPA CON SUPPORTO PER LEVA TONDA - HAND PUMP WITH ROUND LEVER HOLDER

FPM = GUARNIZIONI IN VITON - VITON SEALS

VMQ = GUARNIZIONI IN SILICONE - FLUORINE-SILICONE SEALS

La pompa viene fornita completa di viti di fissaggio e guarnizione NBR. - Hand Pump is supplied with fastening screws and NBR seal.

LEVA - LEVERS

Codice Code	Dimensioni Sizes	TYPE	kg
* PAM0290000	20 x 30 x 600	1	0,71
PAM0290900	20 x 30 x 900	1	1,41
PAM0291000	20 x 30 x 1000	1	1,55
PM00290100	Ø27 x 600 (PAMX)	2	0,91

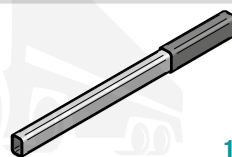

1

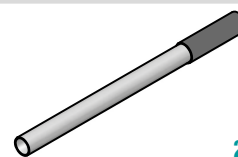

2

* LEVA STANDARD - STANDARD HAND LEVER

KIT RICAMBI - SPARE PARTS

Codice Code	Descrizione Description	Per Pompa For Pump	N°
PAMJDS1245	Kit deviatore 4 vie 4-Way Diverter kit	All type	1
PAMJV01200 PAMJV02500 PAMJV04500	Kit aspirazione Suction valve kit	PAM-TDS 12 PAM-TDS 25 PAM-TDS 45	2
PAMJRA1245	Kit raccordo aspirazione con filtro Suction adapter kit with filter	All type	3
PAMJB01245	Kit bielle Conrod kit	All type	4
PAMJ010001	Supporto leva Hand lever holder	All type	5
PAMJPS1200 PAMJPS2025 PAMJPS4045	Kit pistone+stelo Rod Piston assembled kit	PAM-TDS 12 PAM-TDS 25 PAM-TDS 45	6
PAMJ020015	Soffietto Bellows	All type	7
PAMGTD0012 PAMGTD0025 PAMGTD0045	Kit guarnizioni standard Standard seal kits	PAM-TDS 12 PAM-TDS 25 PAM-TDS 45	8
PAMJ030018	Guarnizione NBR + viti NBR seal + screws	All type	9

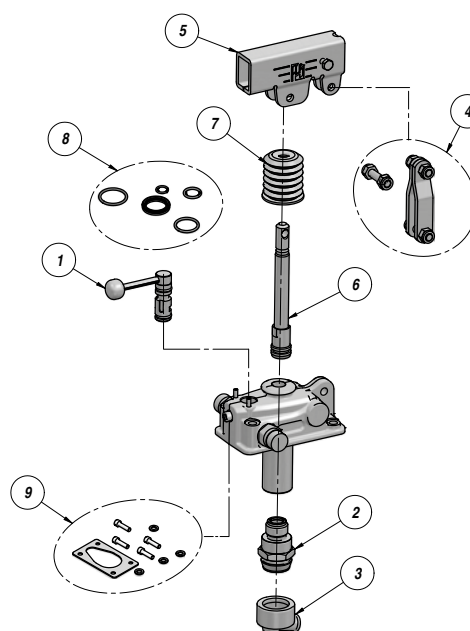

www.hydrotruck.cz
info@hydrotruck.cz

Hydrotruck s.r.o.
Tovačovská 3457/4a
750 02, Přerov
Česká republika